

MQ12 FEMALE 0°

PVC 4X0.34 YELLOW, 5m

Female straight

MQ12, 4-pole

with cable sleeves

Further cable lengths on request.

Plastic housings with good resistance against chemicals and oils.

The resistance to aggressive media should be individually tested for your application. Further details on request.

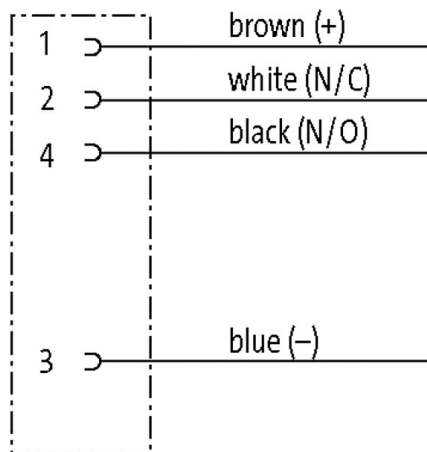
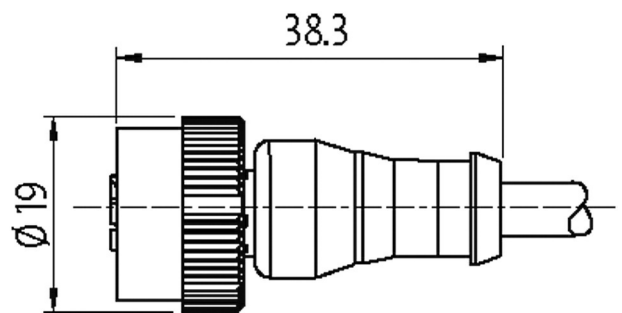
Link to Product**Illustration**

Product may differ from Image

Approvals

cCSAus



* only for products with UL/CSA approved cable

Form

Form

12221

General data	
Temperature range	-25...+85 °C, depending on cable quality
Cables	
No./diameter of wires	4 × 0.34 mm ²
Wire isolation	PVC (br, wh, bl, bk)
Material (jacket)	PVC (UL/CSA)
Outer Ø	5.0 mm ±5%
Bend radius (moving)	10 × outer Ø
Temperature range (fixed)	-30...+80 °C
Temperature range (mobile)	-5...+80 °C
Cable identification	014
Cable Type	1 (PVC)
Approval (cable)	UL (AWM-Style 2464/1731), CSA
Cable weight [g/m]	40,70
Material (wire)	Cu wire, bare
Resistor (core)	max. 60 Ω/km (20 °C)
Single wire Ø (core)	0.15 mm
Construction (core)	19 × 0.15 mm (multi-strand wire class 5)
Diameter (core)	4 × 0.34 mm ²
AWG	similar to AWG 22
Material (wire isolation)	PVC
Material property (wire isolation)	CFC-, cadmium-, silicone- and lead-free
Shore hardness (wire isolation)	45 ±5 D
Wire-Ø incl. isolation	1.25 mm ±5%
Color/numbering of wires	br, bk, bl, wh
Stranding combination	4 wires twisted
Shield	no
Material (jacket)	PVC
Material property (jacket)	CFC-, cadmium-, silicone- and lead-free
Shore hardness (jacket)	85 ±5 A
Outer-Ø (jacket)	5.0 mm ±5%
Color (jacket)	yellow
chemical resistance	good resistance to oil, gasoline and chemicals
thermal resistance	flame retardant UL 1581 VW1 / CSA FT1
Nominal voltage	UL 300 V AC
Test voltage	2000 V AC
Current load capacity	to DIN VDE 0298-4
Temperature range (fixed)	-30...+80 °C
Temperature range (mobile)	-5...+80 °C
Bend radius (fixed)	5 × outer Ø
Bend radius (moving)	10 × outer Ø
Jacket Color	yellow
Technical Data	
Operating voltage	max. 250 V AC/DC
Operating voltage (only UL listed)	30 V AC/DC
Rated surge voltage	2.5 kV
Operating current per contact	max. 4 A
Locking of ports	Quick connection, 1/4 turn

Protection IP65 and IP67 when plugged and screwed down (EN 60529)

Commercial data

country of origin	DE
customs tariff number	85444290
EAN	4048879107303
eClass	27279218
Packaging unit	1

Sketch

Female

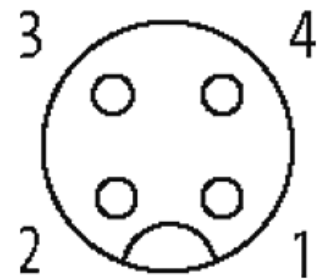

Product may differ from Image